

# STANDARD / OPTION

ENGINE	STD	OPT
Hyundai 6BTAA-5.9 (HM5.9)	●	
<b>HYDRAULIC SYSTEM</b>		
3-power mode, 2-work mode, user mode	●	
Variable power control	●	
Engine auto idle	●	
<b>CAB &amp; INTERIOR</b>		
<b>ISO STANDARD CABIN</b>		
Rise-up type windshield wiper	●	
Radio / USB player		●
12 volt power outlet (24V DC to 12V DC converter)	●	
Electric horn	●	
All-weather steel cab with 360° visibility	●	
Sliding fold-in front window	●	
Sliding side window(LH)	●	
Lockable door	●	
Storage compartment	●	
Sun visor	●	
Door and cab locks, one key	●	
Mechanical suspension seat	●	
Pilot-operated slidable joystick	●	
Cabin lights		●
Cabin roof-steel cover	●	
<b>AUTOMATIC CLIMATE CONTROL</b>		
Air conditioner & heater	●	
Defroster	●	
Starting aid (air grid heater) for cold weather	●	
<b>CENTRALIZED MONITORING</b>		
Engine speed or trip meter / Accel.	●	
Engine coolant temperature gauge	●	
Max power	●	
Low speed / High speed	●	
Auto idle	●	
Air cleaner clogging	●	
Indicators	●	
Fuel level gauge	●	
Hyd. oil temperature gauge	●	
Warnings	●	
Communication error	●	
Low battery	●	
Clock	●	

SAFETY	STD	OPT
Battery master switch	●	
Two front working lights (1 boom mounted, 1 front frame mounted)	●	
Travel alarm		●
Beacon lamp		●
Automatic swing brake	●	
Boom holding system	●	
Arm holding system	●	
Two outside rearview mirror	●	
Wire net guard		●
<b>ATTACHMENT</b>		
<b>BOOMS</b>		
5.68m, 18' 8" Heavy Duty	●	
<b>ARMS</b>		
2.00m, 6' 7"		●
2.40m, 7' 10"		●
2.92m, 9' 7" Heavy Duty	●	
<b>OTHERS</b>		
Pre-Cleaner		●
Removable clean-out dust net for cooler	●	
Removable reservoir tank	●	
Fuel pre-filter	●	
Self-diagnostics system	●	
Hi MATE (Remote Management System)		●
Batteries (2 x 12V x 100 AH)	●	
Fuel filler pump (35 L/min)		●
Single-acting piping kit (breaker, etc.)		●
Accumulator for lowering work equipment	●	
Tool kit		●
<b>COUNTERWEIGHT</b>		
3.6 ton CWT	●	
4.2 ton CWT		●
<b>UNDERCARRIAGE</b>		
Lower frame under cover (normal)	●	
<b>TRACK SHOES</b>		
Triple grousers shoes (600mm, 24")	●	
Triple grousers shoe (800mm, 32")		●
Track rail guard	●	

\* Standard and optional equipment may vary. Contact your Hyundai dealer for more information. The machine may vary according to International standards.  
 \* The photos may include attachments and optional equipment that are not available in your area.  
 \* Materials and specifications are subject to change without advance notice.  
 \* All imperial measurements rounded off to the nearest pound or inch.

Gross Power  
148 HP(110 kW) at 2,000rpm

Net Power  
145 HP(108 kW) at 2,000rpm

Bucket Capacity  
0.87 ~ 1.20m³

Operating Weight  
HX210HD 20,990 kg / 46,270 lb  
HX220HD 21,420 kg / 47,220 lb

# HX210HD HX220HD



**HYUNDAI CONSTRUCTION EQUIPMENT**

Head Office(Sales Office)

3F, Bundang First Tower, 55 Bundang-ro, Bundang-gu, Seongnam-si, Gyeonggi-do, 13591, Korea

PLEASE CONTACT



# WHAT'S NEWEST AND BEST

**HX210HD  
HX220HD**



## SUPERIOR PERFORMANCE

- Heavy Duty Boom & Arm
- New Variable Power Control
- Hyundai 6BTAA-5.9 (HM5.9)
- Reinforced Bucket and Bucket Linkage
- Powerful and Preciser Swing Control
- Strong and Stable Lower Frame
- Single Layer Cooling System
- Minimization of Shock and Vibration through Cab Mounting System

## COMFORTABLE OPERATION

- New Front Side Air-conditioning System
- Smooth Travel Pedal and Foot Rests
- Improved Intelligent Display
- Easy-to-Reach Control Panels
- Wide Cab with Excellent Visibility
- Highly Sensitive Joystick and Easy Entrance
- Wide, Comfortable Operating Space

## SERVICEABILITY AND EASY MAINTENANCE

- Easy to Maintain Engine Components
- Centralized Electric Control Box and Easy Change Air Cleaner Assembly
- Side Cover with Left & Right Swing Open Type
- Large tool box for extra storage
- Highly efficient Hydraulic Pump
- Hi-MATE (Remote Management System) **Option**





# SUPERIOR PERFORMANCE

A new chapter in construction equipment has begun. Making the dream a reality.



## HEAVY DUTY BOOM & ARM

HX210/220HD boom(5.68m) and arm(2.92m) have higher durability than demanded on the site. Attachment performance has been proven through rigorous field testing. No matter how tough the working environment is, you can always rely on the attachment.

**BUILT FOR  
MAXIMUM POWER,  
PERFORMANCE, RELIABILITY.**

### Hyundai 6BTAA-5.9(HM5.9) Engine

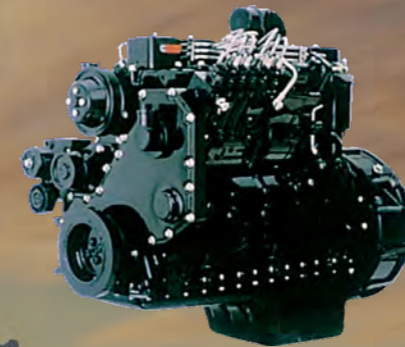

The six cylinders, turbo-charged, 4 cycle, charger air cooled engine is built for power, reliability, economy and low emissions.

### Reinforced Bucket and Bucket Linkage



Sealed and adjustable bucket linkage provides less wear of pins and bushes as well as silent operation. The design includes bucket link durability and anti wear characteristics. Additional reinforcement plates on cutting edge section. Reinforced bucket is made with thicker steel and additional lateral plate.

### Powerful and Preciser Swing Control



Improved shock absorbing characteristics make stopping a precise and smooth action.

**A More Reliable  
Way To Reach  
You Dream.**



The Hyundai 6BTAA-5.9(HM5.9) engine has been designed with 40% fewer parts than the competition. The weight of the machine is reduced without sacrificing strength. You get a proven power plant that meets ecological concerns, without paying a premium for technology you don't need.

### Strong and Stable Lower Frame



Reinforced box-section frame welded, low-stress, high-strength steel, guarantees safety and resistance against external impact when driving on rough ground and working on wet sites through high tensile strength steel panels, with highly durable upper and lower rollers and track guards.

### Single Layer Cooling System

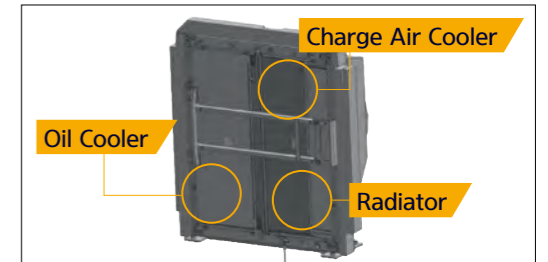

1. Improved cooling performance by changing over to 3 column type structure in a row
2. Easy to clean without disassembling aentire radiator total assembly

### Minimization of Shock and Vibration through Cab Mounting System

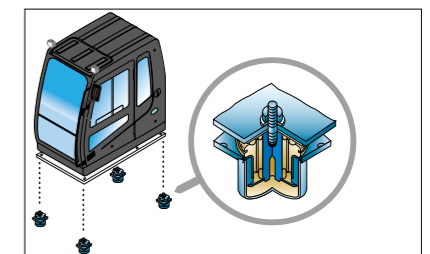

The application of Viscous Mounting to the cabin support provides the operator with a much improved ride. The operator work efficiency will increase as the shock and noise level in the cabin decreases.





# COMFORTABLE OPERATION

Many electronic functions are concentrated in the most convenient spot for operators to improve work efficiency. The highly-advanced infotainment system, a product of HCE's intensive information technology development, enables both productivity and comfort while working! The HX Series is designed with the operator in mind.

**OPERATOR'S COMFORT FOREMOST. WIDE CAB EXCEEDS INDUSTRY STANDARDS.**

## Improved Intelligent Display



Instrument Panel is installed in front of RH console box. It is easy to check all critical systems with easy-to-read indicators.

## Smooth Travel Pedal and Foot Rests



## Easy-to-Reach Control Panels



Switches and other essential controls are located near the operator. This helps keep operator movement to a minimum, enhancing control with less operator fatigue.

## Wide Cab with Excellent Visibility



The cab is roomy and ergonomically designed with low noise level and good visibility. A full view front window and large rear and side windows provide excellent visibility in all directions.

## Highly Sensitive Joystick and Easy Entrance



New joystick grips for precise control have been equipped with double switches.  
- Left: One touch deceleration  
- Right: Horn / Optional

## Wide, Comfortable Operating Space



All the controls are designed and positioned according to the latest ergonomic research. Reinforced pillars have also been added for greater cab rigidity.





# SERVICEABILITY AND EASY MAINTENANCE

New Cabin for More Comfort.

Low noise, low vibration, and ergonomic design make the cabin space more comfortable and pleasant! With focus on safety and convenience of operators, the HX Series allows rapid and safe equipment inspection anytime and anywhere, providing an optimal environment for operators to work.



## HiMATE Option

### IT'S CONVENIENT, EASY AND VALUABLE

Hi MATE, Hyundai's newly developed remote management system, utilizes GPS-satellite technology to provide customers with the highest level of service and product support available.

Hi MATE enables users to remotely evaluate machine performance, access diagnostic information, and verify machine locations at the touch of a button.

### WHAT IS BENEFITS



#### Increase Productivity

It helps you operate machines in efficient. You can check the difference between total engine hours and actual working hours. See how productive your machines are and plan any required cost saving solutions. Hi MATE offers working information such as working / idling hours, fuel consumption and rate.



#### Convenient and Easy Monitoring

There is nothing much to do to monitor your machines. Just log on to the Hi MATE website or mobile application. Hi MATE allows you to watch your machines whenever and wherever you are.



#### Security

Protect your machines from theft or unauthorized usage with Hi MATE. If the machine moves out of the Geo-fence boundary, you will get alerts

### Easy to Maintain Engine Components



The cooling system is provided for optimum operation, guaranteeing longer life for the engine and hydraulic components. Servicing of the engine and hydraulics is considerably simplified due to total accessibility.

### Centralized Electric Control Box and Easy Change Air Cleaner Assembly



Electric control box and Air cleaner are centralized in one or the same compartment for easy service.

### Side Cover with Left & Right Swing Open Type



Easy access to vital components gives unrestricted view of component allows easy maintenance and repair.

\* Photo may include optional equipment.



# SPECIFICATIONS

ENGINE			
Maker / Model	Hyundai 6BTAA-5.9 (HM5.9)		
Type	Water cooled, 4 cycle Diesel, 6-Cylinders in line, direct injection, Turbocharged, charge air cooled, Low emission		
Rated Flywheel Horse Power	SAE	J1995 (gross)	148 HP (110 kW) at 2,000 rpm
		J1349 (net)	145 HP (108 kW) at 2,000 rpm
DIN	6271/1 (gross)	150 PS (110 kW) at 2,000 rpm	
	6271/1 (net)	147 PS (108 kW) at 2,000 rpm	
Max. Torque	64 kgf · m (463 lbf · ft) at 1,300 rpm		
Bore X Stroke	102 X 120 mm (4" X 4.7")		
Piston Displacement	5,900 cc (360 in <sup>3</sup> )		
Batteries	2 X 12 V X 100 Ah		
Starting Motor	24 V, 4.5 kW		
Alternator	24 V, 70 Amp		

HYDRAULIC SYSTEM	
MAIN PUMP	
Type	Variable displacement tandem-axis piston pumps
Max. Flow	2 X 234 ℓ /min (61.8 US gpm / 51.4 UK gpm)
Sub-Pump for Pilot Circuit	Gear pump
Cross-sensing and fuel saving pump system	

HYDRAULIC MOTORS	
Travel	Two speed axial pistons motor with brake valve and parking brake
Swing	Axial piston motor with automatic brake

RELIEF VALVE SETTING	
Implement Circuits	350 kgf/cm <sup>2</sup> (4,978 psi)
Travel	350 kgf/cm <sup>2</sup> (4,978 psi)
Swing Circuit	265 kgf/cm <sup>2</sup> (3,769 psi)
Pilot Circuit	40 kgf/cm <sup>2</sup> (568 psi)
Service Valve	Installed

HYDRAULIC CYLINDERS	
No. of Cylinder	Boom: 2-120 X 1,290 mm (4.7" X 50.8")
Bore X Stroke	Arm: 1-140 X 1,510 mm (5.5" X 59.4") Bucket: 1-120 X 1,055 mm (4.72" X 41.5")

DRIVES & BRAKES	
Drive Method	Fully hydrostatic type
Drive Motor	Axial piston motor, in-shoe design
Reduction System	Planetary reduction gear
Max. Drawbar Pull	21,100 kgf (46,500 lbf)
Max. Travel Speed (high / low)	5.7 km/hr (3.54 mph) / 3.5 km/hr (2.17 mph)
Gradeability	35° (70 %)
Parking Brake	Multi wet disc

CONTROL	
Pilot pressure operated joysticks and pedals with detachable lever provide almost effortless and fatigueless operation.	
Pilot Control	Two joysticks with one safety lever (LH): Swing and arm, (RH): Boom and bucket (ISO)
Traveling and Steering	Two levers with pedals
Engine Throttle	Electric, Dial type
Lights	One light mounted on the boom and one in the battery box

SWING SYSTEM	
Swing Motor	Fixed displacement axial pistons motor
Swing Reduction	Planetary gear reduction
Swing Bearing lubrication	Grease-bathed
Swing Brake	Multi wet disc
Swing Speed	12.2 rpm

COOLANT & LUBRICANT CAPACITY			
	liter	US gal	UK gal
Fuel Tank	340	89.8	74.8
Engine Coolant	20	5.3	4.4
Engine Oil	24	6.3	5.3
Swing Device	6.2	1.3	1.1
Final Drive (Each)	4.5	1.6	1.3
Hydraulic System (Including Tank)	275	72.6	60.5
Hydraulic Tank	160	42.3	35.2

\*( ):option

UNDERCARRIAGE		
The X-leg type center frame is integrally welded with reinforced box-section track frames. The undercarriage includes lubricated rollers, idlers, track adjusters with shock absorbing springs and sprockets, and a track chain with double or triple grouser shoes.		
Model	HX210HD	HX220HD
Center Frame	X-leg type	X-leg type
Track Frame	Pentagonal box type	Pentagonal box type
No. of Shoes on Each Side	46 EA	49 EA
No. of Carrier Rollers on Each Side	2 EA	2 EA
No. of Track Rollers on Each Side	7 EA	9 EA
No. of Rail Guards on Each Side	1 EA	2 EA

OPERATING WEIGHT (APPROXIMATE)	
Operating weight, including 5,680 mm (18' 8") boom, 2,920 mm (9' 7") arm, SAE heaped 0.92m <sup>3</sup> (1.20 yd <sup>3</sup> ) bucket, lubricant, coolant, full fuel tank, full hydraulic tank, and all standard equipments.	
MAJOR COMPONENT WEIGHT	
Upperstructure	5,600 kg (12,350 lb)
Counterweight	3,600 kg (7,937 lb)
Boom (with Arm Cylinder)	2,070 kg (4,560 lb)

OPERATING WEIGHT			
Shoes		Operating Weight	Ground Pressure
Type	Width mm (in)	kg (lb)	kgf/cm <sup>2</sup> (psi)
Triple Grouser	600 (24")	HX210HD	20,990 (46,270) 0.48 (6.86)
		HX220HD	21,420 (47,220) 0.45 (6.50)
	800 (32")	HX210HD	21,540 (47,490) 0.42 (6.03)
		HX220HD	22,200 (48,940) 0.35 (5.06)

# BUCKET SELECTION GUIDE & DIGGING FORCE

## BUCKETS

All buckets are welded with high-strength steel.

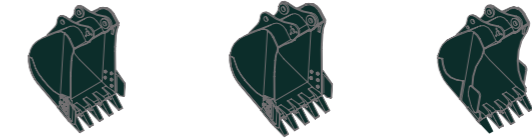

SAE heaped m<sup>3</sup> (yd<sup>3</sup>)

0.92 (1.20)

1.20 (1.57)

⊙ 0.87 (1.14)  
⊙ 1.20 (1.57)

Type	Capacity m <sup>3</sup> (yd <sup>3</sup> )		Width mm (in)	Weight kg (lb)	Tooth EA	Recommendation mm (ft-in)					
	SAE heaped	CECE heaped				5,680 (18' 8") Boom					
						3.6 ton CWT			4.2 ton CWT		
					2,000 (6' 7") Arm	2,400 (7' 10") Arm	2,920 (9' 7") Arm	2,000 (6' 7") Arm	2,400 (7' 10") Arm	2,920 (9' 7") Arm	
HX210HD	0.92 (1.20)	0.80 (1.05)	1,080 (42.5")	765 (1,690)	5	●	⊙	■	●	●	⊙
	1.20 (1.57)	1.00 (1.31)	1,330 (52.4")	810 (1,790)	5	■	▲	▲	⊙	■	▲
	⊙ 0.87 (1.14)	0.75 (0.98)	1,140 (44.9")	900 (1,980)	5	●	⊙	■	●	●	⊙
	⊙ 1.20 (1.57)	1.00 (1.31)	1,410 (55.5")	1,030 (2,270)	5	■	▲	x	■	■	▲
HX220HD	0.92 (1.20)	0.80 (1.05)	1,080 (42.5")	765 (1,690)	5	●	●	⊙	●	●	●
	1.20 (1.57)	1.00 (1.31)	1,330 (52.4")	810 (1,790)	5	⊙	■	▲	⊙	⊙	■
	⊙ 0.87 (1.14)	0.75 (0.98)	1,140 (44.9")	900 (1,980)	5	●	●	⊙	●	●	●
	⊙ 1.20 (1.57)	1.00 (1.31)	1,410 (55.5")	1,030 (2,270)	5	■	■	▲	⊙	■	■

⊙ Rock-Heavy duty bucket

● : Applicable for materials with density of 2,100 kg/m<sup>3</sup> (3,500 lb/yd<sup>3</sup>) or less  
 ⊙ : Applicable for materials with density of 1,800 kg/m<sup>3</sup> (3,000 lb/yd<sup>3</sup>) or less  
 ■ : Applicable for materials with density of 1,500 kg/m<sup>3</sup> (2,500 lb/yd<sup>3</sup>) or less  
 ▲ : Applicable for materials with density of 1,200 kg/m<sup>3</sup> (2,000 lb/yd<sup>3</sup>) or less  
 - : Not Recommended

## ATTACHMENT

5.68 m (18' 8"), 8.20 m (26' 11") Booms and 2.0 m (6' 7"), 2.4m (7' 10"), 2.92 m (9' 7") Arms are available.

DIGGING FORCE					
Boom	Length	mm (ft.in)	*5,680 (18' 8")		
	Weight	kg (lb)	2,070 (4,560)		
Arm	Length	mm (ft.in)	2,000 (6' 7")	2,400 (7' 10")	*2,920 (9' 7")
	Weight	kg (lb)	975 (2,150)	1,045 (2,300)	1,095 (2,410)
Bucket Digging Force	SAE	kN	133.4	133.4	133.4
		kgf	13,600	13,600	13,600
		lbf	29,980	29,980	29,980
	ISO	kN	152.0	152.0	152.0
		kgf	15,500	15,500	15,500
		lbf	34,170	34,170	34,170
Arm Crowd Force	SAE	kN	144.2	119.6	102.0
		kgf	14,700	12,200	10,400
		lbf	32,410	26,900	22,930
	ISO	kN	151.0	125.5	106.9
		kgf	15,400	12,800	10,900
		lbf	33,950	28,220	24,030

Note: Boom weight includes arm cylinder, piping, and pin  
 Arm weight includes bucket cylinder, linkage, and pin  
 \* : Heavy duty type

# DIMENSIONS & WORKING RANGE

## HX210HD/HX220HD DIMENSIONS

5.68 m (18' 8") Boom and 2.0 m (6' 7"), 2.4 m (7' 10"), 2.92 m (9' 7") Arm

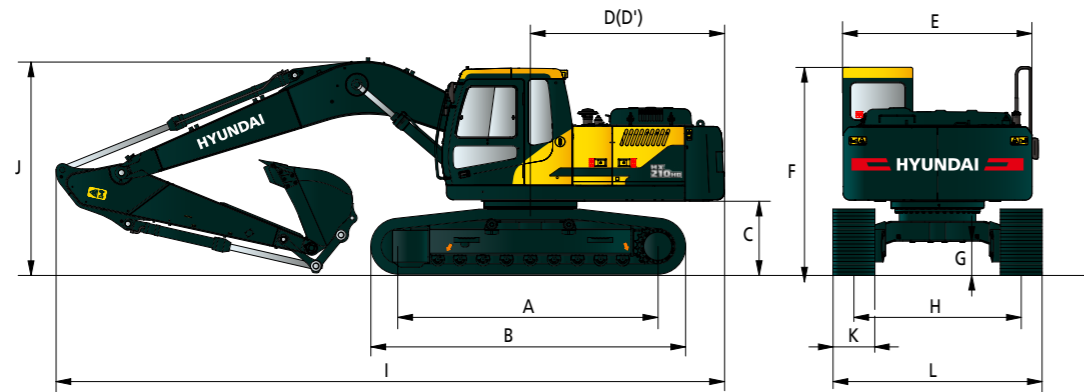

Unit : mm (ft.-in)

Model	HX210HD	HX220HD
A Tumbler Distance	3,360 (11' 0")	3,650 (12' 0")
B Overall Length of Crawler	4,170 (13' 8")	4,440 (14' 7")
C Ground Clearance of Counterweight	1,060 (3' 6")	1,060 (3' 6")
D Tail Swing Radius	2,845 (9' 4")	2,845 (9' 4")
D' Rear-end Length	2,770 (9' 1")	2,770 (9' 1")
E Overall Width of Upperstructure	2,700 (8' 10")	2,700 (8' 10")
F Overall Height of Cab	3,000 (9' 10")	3,000 (9' 10")
G Min. Ground Clearance	470 (1' 7")	470 (1' 7")
H Track Gauge	2,200 (7' 3")	2,390 (7' 10")

Boom length		5,680 (18' 8")		
Arm length	2,000 (6' 7")	2,400 (7' 10")	2,920 (9' 7")	
I Overall Length	9,650 (31' 8")	9,570 (31' 5")	9,530 (31' 3")	
J Overall Height of Boom	3,200 (10' 6")	3,110 (10' 2")	3,030 (9' 10")	
HX210HD				
K Track Shoe Width	Type	Triple Grouser		
	Width	600 (24")	800 (32")	
L Overall Width	2,800 (9' 2")		3,000 (9' 10")	
HX220HD				
K Track Shoe Width	Type	Triple Grouser		
	Width	600 (24")	800 (32")	
L Overall Width	2,990 (9' 10")		3,190 (10' 6")	

## HX210HD/HX220HD WORKING RANGE

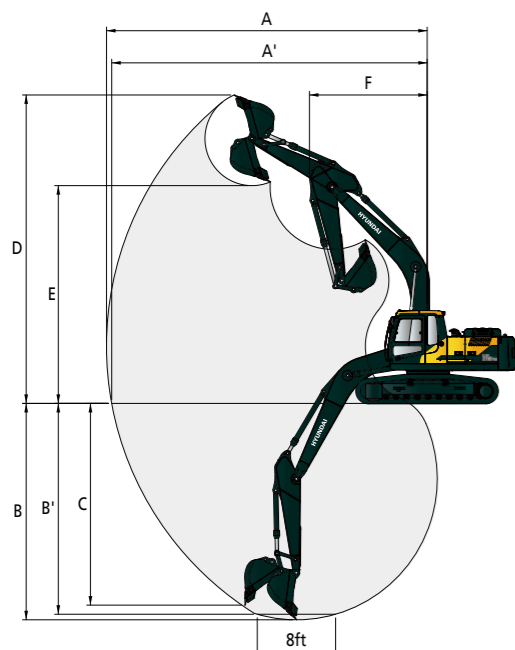

Unit : mm (ft.-in)

Model	HX210HD/HX220HD		
Boom Length	5,680 (18' 8")		
Arm Length	2,000 (6' 7")	2,400 (7' 10")	2,920 (9' 7")
A Max. Digging Reach	9,140 (30' 0")	9,500 (31' 2")	9,980 (32' 9")
A' Max. Digging Reach on Ground	8,960 (29' 5")	9,330 (30' 7")	9,820 (32' 3")
B Max. Digging Depth	5,820 (19' 1")	6,220 (20' 5")	6,730 (22' 1")
B' Max. Digging Depth (8' Level)	5,580 (18' 4")	6,010 (19' 9")	6,560 (21' 6")
C Max. Vertical Wall Digging Depth	5,280 (17' 4")	5,720 (18' 9")	6,280 (20' 7")
D Max. Digging Height	9,140 (30' 0")	9,340 (30' 8")	9,600 (31' 6")
E Max. Dumping Height	6,330 (20' 9")	6,520 (21' 5")	6,780 (22' 3")
F Min. Swing Radius	3,750 (12' 4")	3,740 (12' 3")	3,670 (12' 0")

# LIFTING CAPACITY

Rating over-front Rating over-side or 360 degree

## HX210HD MONO BOOM

5.68 m (18' 8") boom, 2.00 m (6' 7") arm equipped with 600 mm (24") triple grouser shoe and 3,600 kg counter weight

Load Point Height m (ft)		Lift-Point Radius								At Max. Reach		
		3.0m (9.8ft)		4.5m (14.8ft)		6.0m (19.7ft)		7.5m (24.6ft)		Capacity	Reach	
												m (ft)
7.5m 24.6ft	kg lb									*5,700 *12,570	*5,700 *12,570	5.00 (16.4)
6.0m 19.7ft	kg lb					*5,440 *11,990	4,320 9,520			*5,500 *12,130	3,910 8,620	6.35 (20.8)
4.5m 14.8ft	kg lb			*6,870 *15,150	6,500 14,330	*5,780 *12,740	4,190 9,240			4,890 10,780	3,160 6,970	7.14 (23.4)
3.0m 9.8ft	kg lb			*8,650 *19,070	5,950 13,120	6,250 13,780	3,970 8,750	4,430 9,770	2,840 6,260	4,390 9,680	2,810 6,190	7.55 (24.8)
1.5m 4.9ft	kg lb					6,020 13,270	3,770 8,310	4,350 9,590	2,760 6,080	4,230 9,330	2,690 5,930	7.64 (25.1)
0.0m 0.0ft	kg lb					9,160 20,190	5,420 11,950	5,890 12,990	3,650 8,050	4,360 9,610	2,760 6,080	7.43 (24.4)
-1.5m -4.9ft	kg lb					9,180 20,240	5,430 11,970	5,880 12,960	3,640 8,020	4,870 10,740	3,060 6,750	6.88 (22.6)
-3.0m -9.8ft	kg lb	*12,330 *27,180	10,710 23,610	*9,100 *20,060	5,570 12,280					6,170 13,600	3,860 8,510	5.90 (19.4)

5.68 m (18' 8") boom, 2.00 m (6' 7") arm equipped with 600 mm (24") triple grouser shoe and 4,200 kg counter weight

Load Point Height m (ft)		Lift-Point Radius								At Max. Reach		
		3.0m (9.8ft)		4.5m (14.8ft)		6.0m (19.7ft)		7.5m (24.6ft)		Capacity	Reach	
												m (ft)
7.5m 24.6ft	kg lb									*5,700 *12,570	*5,700 *12,570	5.00 (16.4)
6.0m 19.7ft	kg lb					*5,440 *11,990	4,660 10,270			*5,500 *12,130	4,220 9,300	6.35 (20.8)
4.5m 14.8ft	kg lb			*6,870 *15,150	*6,870 *15,150	*5,780 *12,740	4,530 9,990			5,220 11,510	3,430 7,560	7.14 (23.4)
3.0m 9.8ft	kg lb			*8,650 *19,070	6,430 14,180	*6,510 *14,350	4,310 9,500	4,750 10,470	3,100 6,830	4,700 10,360	3,060 6,750	7.55 (24.8)
1.5m 4.9ft	kg lb					6,450 14,220	4,100 9,040	4,660 10,270	3,020 6,660	4,540 10,010	2,940 6,480	7.64 (25.1)
0.0m 0.0ft	kg lb					9,810 21,630	5,900 13,010	6,320 13,930	3,990 8,800	4,680 10,320	3,010 6,640	7.43 (24.4)
-1.5m -4.9ft	kg lb					9,830 21,670	5,920 13,050	6,300 13,890	3,970 8,750	5,220 1,1510	3,340 7,360	6.88 (22.6)
-3.0m -9.8ft	kg lb	*12,330 *27,180	11,600 25,570	*9,100 *20,060	6,060 13,360					6,600 1,4550	4,200 9,260	5.90 (19.4)

- Lifting capacity are based on ISO 10567.
- Lifting capacity of the ROBEX series does not exceed 75% of tipping load with the machine on firm, level ground or 87% of full hydraulic capacity.
- The Lift-point is bucket pivot mounting pin on the arm (without bucket mass).
- (\*) indicates load limited by hydraulic capacity.

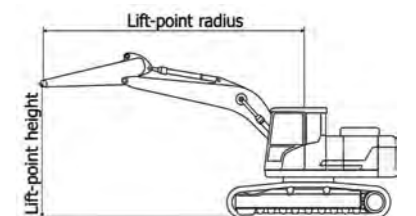

# LIFTING CAPACITY

Rating over-front Rating over-side or 360 degree

## HX210HD MONO BOOM

5.68 m (18' 8") boom, 2.40 m (7' 10") arm equipped with 600 mm (24") triple grouser shoe and 3,600 kg counter weight

Load Point Height m (ft)	Lift-Point Radius								At Max. Reach			
	3.0m (9.8ft)		4.5m (14.8ft)		6.0m (19.7ft)		7.5m (24.6ft)		Capacity		Reach	
											m (ft)	
7.5m 24.6ft	kg lb									*5,080 *11,200	4,910 10,820	5.58 (18.3)
6.0m 19.7ft	kg lb			*4,980 *10,980	4,380 9,660					*4,620 *10,190	3,490 7,690	6.82 (22.4)
4.5m 14.8ft	kg lb			*6,320 *13,930	*6,320 *13,930	*5,430 *11,970	4,230 9,330	4,520 9,960	2,920 6,440	4,470 9,850	2,880 6,350	7.55 (24.8)
3.0m 9.8ft	kg lb			*8,110 *17,880	6,050 13,340	*6,200 *13,670	3,990 8,800	4,440 9,790	2,840 6,260	4,050 9,930	2,590 5,710	7.94 (26.1)
1.5m 4.9ft	kg lb			9,370 20,660	5,590 12,320	6,030 13,290	3,770 8,310	4,330 9,550	2,740 6,040	3,910 8,620	2,480 5,470	8.03 (26.3)
0.0m 0.0ft	kg lb			9,130 20,130	5,390 11,880	5,870 12,940	3,630 8,000	4,260 9,390	2,680 5,910	4,010 8,840	2,530 5,580	7.83 (25.7)
-1.5m -4.9ft	kg lb	*10,830 *23,880	10,320 22,750	9,110 20,080	5,370 11,840	5,820 12,830	3,590 7,910			4,420 9,740	2,770 6,110	7.31 (24.0)
-3.0m -9.8ft	kg lb	*13,210 *29,120	10,520 23,190	9,230 20,350	5,470 12,060	5,910 13,030	3,670 8,090			5,410 11,930	3,390 7,470	6.40 (21.0)
-4.5m -14.8ft	kg lb			*7,130 *15,720	5,770 12,720					*6,300 *13,890	5,160 11,380	4.89 (16.0)

5.68 m (18' 8") boom, 2.40 m (7' 10") arm equipped with 600 mm (24") triple grouser shoe and 4,200 kg counter weight

Load Point Height m (ft)	Lift-Point Radius								At Max. Reach			
	3.0m (9.8ft)		4.5m (14.8ft)		6.0m (19.7ft)		7.5m (24.6ft)		Capacity		Reach	
											m (ft)	
7.5m 24.6ft	kg lb									*5,080 *11,200	*5,080 *11,200	5.58 (18.3)
6.0m 19.7ft	kg lb			*4,980 *10,980	4,710 10,380					*4,620 *10,190	3,780 8,330	6.82 (22.4)
4.5m 14.8ft	kg lb			*6,320 *13,930	*6,320 *13,930	*5,430 *11,970	4,560 10,050	4,840 10,670	3,180 7,010	*4,490 *9,900	3,130 6,900	7.55 (24.8)
3.0m 9.8ft	kg lb			*8,110 *17,880	6,530 14,400	*6,200 *13,670	4,330 9,550	4,750 10,470	3,100 6,830	4,340 9,570	2,820 6,220	7.94 (26.1)
1.5m 4.9ft	kg lb			*9,670 *21,320	6,070 13,380	6,450 14,220	4,100 9,040	4,640 10,230	3,000 6,610	4,200 9,260	2,710 5,970	8.03 (26.3)
0.0m 0.0ft	kg lb			9,780 21,560	5,870 12,940	6,290 13,870	3,960 8,730	4,570 10,080	2,930 6,460	4,310 9,500	2,770 6,110	7.83 (25.7)
-1.5m -4.9ft	kg lb	*10,830 *23,880	*10,830 *23,880	9,760 21,520	5,850 12,900	6,240 13,760	3,920 8,640			4,740 10,450	3,030 6,680	7.31 (24.0)
-3.0m -9.8ft	kg lb	*13,210 *29,120	11,400 25,130	*9,460 *20,860	5,950 13,120	6,330 13,960	4,000 8,820			5,800 12,790	3,690 8,140	6.40 (21.0)
-4.5m -14.8ft	kg lb			*7,130 *15,720	6,250 13,780					*6,300 *13,890	5,590 12,320	4.89 (16.0)

- Lifting capacity are based on ISO 10567.
- Lifting capacity of the ROBEX series does not exceed 75% of tipping load with the machine on firm, level ground or 87% of full hydraulic capacity.
- The Lift-point is bucket pivot mounting pin on the arm (without bucket mass).
- (\*) indicates load limited by hydraulic capacity.

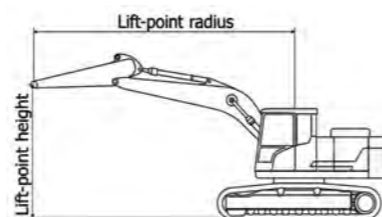

Rating over-front Rating over-side or 360 degree

## HX210HD MONO BOOM

5.68 m (18' 8") boom, 2.92 m (9' 7") arm equipped with 600 mm (24") triple grouser shoe, and 3,600 kg counterweight.

Load Point Height m (ft)	Lift-Point Radius								At Max. Reach													
	1.5m (4.9ft)		3.0m (9.8ft)		4.5m (14.8ft)		6.0m (19.7ft)		7.5m (24.6ft)		Capacity		Reach									
													m (ft)									
7.5m 24.6ft	kg lb											*4,440 *9,790	4,430 9,770	*3,360 *7,410	*3,360 *7,410	6.26 (20.5)						
6.0m 19.7ft	kg lb											*4,410 *9,720	*4,410 *9,720	*3,090 *6,810	3,050 6,720	7.38 (24.2)						
4.5m 14.8ft	kg lb											*4,920 *10,850	4,260 9,390	4,540 10,010	2,930 6,460	*3,010 *6,640	2,560 5,640	8.07 (26.5)				
3.0m 9.8ft	kg lb											*7,340 *16,180	6,150 13,560	*5,740 *12,650	4,000 8,820	4,420 9,740	2,820 6,220	*3,060 *6,750	2,310 5,090	8.43 (27.7)		
1.5m 4.9ft	kg lb											*9,060 *19,970	5,610 12,370	6,010 13,250	3,740 8,250	4,290 9,460	2,700 5,950	*3,240 *7,140	2,210 4,870	8.51 (27.9)		
0.0m 0.0ft	kg lb											*5,920 *13,050	*5,920 *13,050	9,070 20,000	5,320 11,730	5,810 12,810	3,560 7,850	4,180 9,220	2,600 5,730	*3,580 *7,890	2,240 4,940	8.32 (27.3)
-1.5m -4.9ft	kg lb	*6,490 *14,310	*6,490 *14,310	*10,390 *22,910	10,020 22,090	8,970 19,780	5,240 11,550	5,720 12,610	3,480 7,670	4,150 9,150	2,570 5,670			3,910 8,620	2,430 5,360	7.84 (25.7)						
-3.0m -9.8ft	kg lb	*11,110 *24,490	*11,110 *24,490	*14,070 *31,020	10,210 22,510	9,050 19,950	5,300 11,680	5,760 12,700	3,520 7,760					4,640 10,230	2,880 6,350	7.00 (23.0)						
-4.5m -14.8ft	kg lb			*11,520 *25,400	10,600 23,370								*8,120 *17,900	5,520 12,170			*6,030 *13,290	4,030 8,880	5.65 (18.5)			

5.68 m (18' 8") boom, 2.92 m (9' 7") arm equipped with 600 mm (24") triple grouser shoe, and 4,200 kg counterweight.

Load Point Height m (ft)	Lift-Point Radius								At Max. Reach													
	1.5m (4.9ft)		3.0m (9.8ft)		4.5m (14.8ft)		6.0m (19.7ft)		7.5m (24.6ft)		Capacity		Reach									
													m (ft)									
7.5m 24.6ft	kg lb											*4,440 *9,790	*4,440 *9,790	*3,360 *7,410	*3,360 *7,410	6.26 (20.5)						
6.0m 19.7ft	kg lb											*4,410 *9,720	*4,410 *9,720	*3,090 *6,810	*3,090 *6,810	7.38 (24.2)						
4.5m 14.8ft	kg lb											*4,920 *10,850	4,590 10,120	*4,660 *10,270	3,180 7,010	*3,010 *6,640	2,790 6,150	8.07 (26.5)				
3.0m 9.8ft	kg lb											*7,340 *16,180	6,630 14,620	*5,740 *12,650	4,330 9,550	4,740 10,450	3,070 6,770	*3,060 *6,750	2,530 5,580	8.43 (27.7)		
1.5m 4.9ft	kg lb											*9,060 *19,970	6,090 13,430	6,430 14,180	4,080 8,990	4,600 10,140	2,950 6,500	*3,240 *7,140	2,430 5,360	8.51 (27.9)		
0.0m 0.0ft	kg lb											*5,920 *13,050	*5,920 *13,050	9,720 21,430	5,800 12,790	6,230 13,730	3,890 8,580	4,500 9,920	2,850 6,280	*3,580 *7,890	2,460 5,420	8.32 (27.3)
-1.5m -4.9ft	kg lb	*6,490 *14,310	*6,490 *14,310	*10,390 *22,910	10,390 22,910	9,620 21,210	5,720 12,610	6,140 13,540	3,820 8,420	4,460 9,830	2,820 6,220			*4,190 *9,240	2,670 5,890	7.84 (25.7)						
-3.0m -9.8ft	kg lb	*11,110 *24,490	*11,110 *24,490	*14,070 *31,020	11,090 24,450	9,690 21,360	5,780 12,740	6,180 13,620	3,850 8,490					4,980 10,980	3,160 6,970	7.00 (23.0)						
-4.5m -14.8ft	kg lb			*11,520 *25,400	11,480 25,310								*8,120 *17,900	6,000 13,230			*6,030 *13,290	4,390 9,680	5.65 (18.5)			

- Lifting capacity are based on ISO 10567.
- Lifting capacity of the ROBEX series does not exceed 75% of tipping load with the machine on firm, level ground or 87% of full hydraulic capacity.
- The Lift-point is bucket pivot mounting pin on the arm (without bucket mass).
- (\*) indicates load limited by hydraulic capacity.

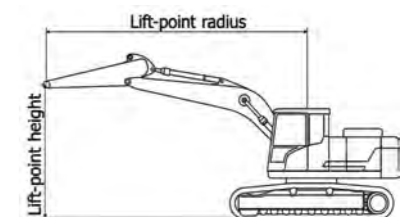



# LIFTING CAPACITY

Rating over-front Rating over-side or 360 degree

## HX220HD MONO BOOM

5.68 m (18' 8") boom, 2.00 m (6' 7") arm equipped with 600 mm (24") triple grouser shoe and 3,600 kg counter weight

Load Point Height m (ft)	Lift-Point Radius								At Max. Reach			
	3.0m (9.8ft)		4.5m (14.8ft)		6.0m (19.7ft)		7.5m (24.6ft)		Capacity		Reach	
											m (ft)	
7.5m 24.6ft	kg lb									*5,700 *12,570	*5,700 *12,570	5.00 (16.4)
6.0m 19.7ft	kg lb			*5,440 *11,990	4,810 10,600					*5,500 *12,130	4,360 9,610	6.35 (20.8)
4.5m 14.8ft	kg lb		*6,870 *15,150	*6,870 *15,150	*5,780 *12,740	4,680 10,320				5,510 12,150	3,540 7,800	7.14 (23.4)
3.0m 9.8ft	kg lb		*8,650 *19,070	6,710 14,790	*6,510 *14,350	4,450 9,810	5,000 11,020	3,190 7,030		4,950 10,910	3,160 6,970	7.55 (24.8)
1.5m 4.9ft	kg lb				6,850 15,100	4,250 9,370	4,920 10,850	3,110 6,860		4,780 10,540	3,030 6,680	7.64 (25.1)
0.0m 0.0ft	kg lb		*10,480 *23,100	6,160 13,580	6,710 14,790	4,130 9,110				4,940 10,890	3,110 6,860	7.43 (24.4)
-1.5m -4.9ft	kg lb		*10,180 *22,440	6,180 13,620	6,700 14,770	4,120 9,080				5,520 12,170	3,450 7,610	6.88 (22.6)
-3.0m -9.8ft	kg lb	*12,330 *27,180	*12,330 *27,180	*9,100 *20,060	6,320 13,930					*6,650 *14,660	4,340 9,570	5.91 (19.4)

5.68 m (18' 8") boom, 2.00 m (6' 7") arm equipped with 600 mm (24") triple grouser shoe and 4,200 kg counter weight

Load Point Height m (ft)	Lift-Point Radius								At Max. Reach			
	3.0m (9.8ft)		4.5m (14.8ft)		6.0m (19.7ft)		7.5m (24.6ft)		Capacity		Reach	
											m (ft)	
7.5m 24.6ft	kg lb									*5,700 *12,570	*5,700 *12,570	5.00 (16.4)
6.0m 19.7ft	kg lb			*5,440 *11,990	51,60 11,380					*5,500 *12,130	4,680 10,320	6.35 (20.8)
4.5m 14.8ft	kg lb		*6,870 *15,150	*6,870 *15,150	*5,780 *12,740	5,030 11,090				*5,540 *12,210	3,820 8,420	7.14 (23.4)
3.0m 9.8ft	kg lb		*8,650 *19,070	7,220 15,920	*6,510 *14,350	4,800 10,580	5,340 11,770	3,450 7,610		5,280 11,640	3,420 7,540	7.55 (24.8)
1.5m 4.9ft	kg lb				*7,230 *15,940	4,600 10,140	5,250 11,570	3,370 7,430		5,110 11,270	3,290 7,250	7.64 (25.1)
0.0m 0.0ft	kg lb		*10,480 *23,100	6,680 14,730	7,170 15,810	4,480 9,880				5,270 11,620	3,370 7,430	7.43 (24.4)
-1.5m -4.9ft	kg lb		*10,180 *22,440	6,690 14,750	7,150 15,760	4,460 9,830				5,890 12,990	3,750 8,270	6.88 (22.6)
-3.0m -9.8ft	kg lb	*12,330 *27,180	*12,330 *27,180	*9,100 *20,060	6,840 15,080					*6,650 *14,660	4,700 10,360	5.91 (19.4)

- Lifting capacity are based on ISO 10567.
- Lifting capacity of the ROBEX series does not exceed 75% of tipping load with the machine on firm, level ground or 87% of full hydraulic capacity.
- The Lift-point is bucket pivot mounting pin on the arm (without bucket mass).
- (\*) indicates load limited by hydraulic capacity.

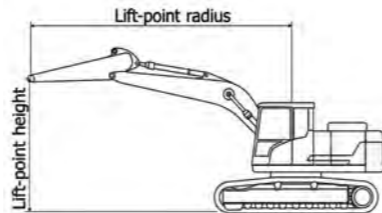

Rating over-front Rating over-side or 360 degree

## HX220HD MONO BOOM

5.68 m (18' 8") boom, 2.40 m (7' 10") arm equipped with 600 mm (24") triple grouser shoe and 3,600 kg counter weight

Load Point Height m (ft)	Lift-Point Radius								At Max. Reach			
	3.0m (9.8ft)		4.5m (14.8ft)		6.0m (19.7ft)		7.5m (24.6ft)		Capacity		Reach	
											m (ft)	
7.5m 24.6ft	kg lb									*5,080 *11,200	*5,080 *11,200	5.58 (18.3)
6.0m 19.7ft	kg lb				*4,980 *10,980	4,870 10,740				*4,620 *10,190	3,900 8,600	6.81 (22.4)
4.5m 14.8ft	kg lb		*6,320 *13,930	*6,320 *13,930	*5,430 *11,970	4,710 10,380	*4,990 *11,000	3,270 7,210		*4,490 *9,900	3,230 7,120	7.55 (24.8)
3.0m 9.8ft	kg lb		*8,110 *17,880	6,810 15,010	*6,200 *13,670	4,480 9,880	5,010 11,050	3,190 7,030		4,570 10,080	2,910 6,420	7.94 (26.1)
1.5m 4.9ft	kg lb		*9,660 *21,300	6,340 13,980	6,860 15,120	4,250 9,370	4,900 10,800	3,090 6,810		4,420 9,740	2,790 6,150	8.03 (26.3)
0.0m 0.0ft	kg lb		*10,360 *22,840	6,140 13,540	6,690 14,750	4,100 9,040	4,820 10,630	3,020 6,660		4,540 10,010	2,850 6,280	7.83 (25.7)
-1.5m -4.9ft	kg lb	*10,820 *23,850	*10,820 *23,850	*10,290 *22,690	6,110 13,470	6,640 14,640	4,060 8,950			5,010 11,050	3,130 6,900	7.31 (24.0)
-3.0m -9.8ft	kg lb	*13,210 *29,120	12,210 26,920	*9,460 *20,860	6,220 13,710	6,740 14,860	4,140 9,130			6,140 13,540	3,820 8,420	6.41 (21.0)
-4.5m -14.8ft	kg lb			*7,130 *15,720	6,530 14,400					*6,300 *13,890	5,820 12,830	4.89 (16.0)

5.68 m (18' 8") boom, 2.40 m (7' 10") arm equipped with 600 mm (24") triple grouser shoe and 4,200 kg counter weight

Load Point Height m (ft)	Lift-Point Radius								At Max. Reach			
	3.0m (9.8ft)		4.5m (14.8ft)		6.0m (19.7ft)		7.5m (24.6ft)		Capacity		Reach	
											m (ft)	
7.5m 24.6ft	kg lb									*5,080 *11,200	*5,080 *11,200	5.58 (18.3)
6.0m 19.7ft	kg lb				*4,980 *10,980	4,980 10,980				*4,620 *10,190	4,190 9,240	6.81 (22.4)
4.5m 14.8ft	kg lb		*6,320 *13,930	*6,320 *13,930	*5,430 *11,970	5,060 11,160	*4,990 *11,000	3,540 7,800		*4,490 *9,900	3,490 7,690	7.55 (24.8)
3.0m 9.8ft	kg lb		*8,110 *17,880	7,330 16,160	*6,200 *13,670	4,820 10,630	5,340 11,770	3,460 7,630		*4,580 *10,100	3,150 6,940	7.94 (26.1)
1.5m 4.9ft	kg lb		*9,660 *21,300	6,860 15,120	*7,000 *15,430	4,600 10,140	5,230 11,530	3,350 7,390		4,730 10,430	3,040 6,700	8.03 (26.3)
0.0m 0.0ft	kg lb		*10,360 *22,840	6,650 14,660	7,140 15,740	4,450 9,810	5,160 11,380	3,290 7,250		4,860 10,710	3,100 6,830	7.83 (25.7)
-1.5m -4.9ft	kg lb	*10,820 *23,850	*10,820 *23,850	*10,290 *22,690	6,620 14,590	7,090 15,630	4,410 9,720			5,350 11,790	3,400 7,500	7.31 (24.0)
-3.0m -9.8ft	kg lb	*13,210 *29,120	13,160 29,010	*9,460 *20,860	6,730 14,840	*6,940 *15,300	4,490 9,900			*6,280 *13,850	4,140 9,130	6.41 (21.0)
-4.5m -14.8ft	kg lb			*7,130 *15,720	7,040 15,520					*6,300 *13,890	6,270 13,820	4.89 (16.0)

- Lifting capacity are based on ISO 10567.
- Lifting capacity of the ROBEX series does not exceed 75% of tipping load with the machine on firm, level ground or 87% of full hydraulic capacity.
- The Lift-point is bucket pivot mounting pin on the arm (without bucket mass).
- (\*) indicates load limited by hydraulic capacity.

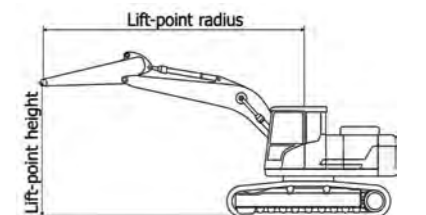















# LIFTING CAPACITY

# MEMO













 Rating over-front  Rating over-side or 360 degree

## HX220HD MONO BOOM

5.68 m (18' 8") boom, 2.92 m (9' 7") arm equipped with 600 mm (24") triple grouser shoe, and 3,600 kg counter weight.

Load Point Height m (ft)	Lift-Point Radius										At Max. Reach			
	1.5m (4.9ft)		3.0m (9.8ft)		4.5m (14.8ft)		6.0m (19.7ft)		7.5m (24.6ft)		Capacity		Reach	
													m (ft)	
7.5m 24.6ft	kg							*4,440	*4,440			*3,360	*3,360	6.26
	lb							*9,790	*9,790			*7,410	*7,410	(20.5)
6.0m 19.7ft	kg							*4,410	*4,410			*3,090	*3,090	7.38
	lb							*9,720	*9,720			*6,810	*6,810	(24.2)
4.5m 14.8ft	kg							*4,920	4,750	*4,660	3,280	*3,010	2,870	8.07
	lb							*10,850	10,470	*10,270	7,230	*6,640	6,330	(26.5)
3.0m 9.8ft	kg				*7,340	6,920		*5,740	4,480	5,000	3,170	*3,060	2,600	8.43
	lb				*16,180	15,260		*12,650	9,880	11,020	6,990	*6,750	5,730	(27.7)
1.5m 4.9ft	kg				*9,060	6,370		*6,610	4,220	4,860	3,040	*3,240	2,500	8.51
	lb				*19,970	14,040		*14,570	9,300	10,710	6,700	*7,140	5,510	(27.9)
0.0m 0.0ft	kg		*5,910	*5,910	*10,050	6,070		6,630	4,040	4,750	2,950	*3,580	2,540	8.32
	lb		*13,030	*13,030	*22,160	13,380		14,620	8,910	10,470	6,500	*7,890	5,600	(27.3)
-1.5m -4.9ft	kg	*6,490	*6,490	*10,380	*10,380	*10,260	5,980	6,540	3,960	4,720	2,920	*4,190	2,750	7.84
	lb	*14,310	*14,310	*22,880	*22,880	*22,620	13,180	14,420	8,730	10,410	6,440	*9,240	6,060	(25.7)
-3.0m -9.8ft	kg	*11,110	*11,110	*14,070	11,880	*9,740	6,050	6,580	3,990			5,270	3,260	7.00
	lb	*24,490	*24,490	*31,020	26,190	*21,470	13,340	14,510	8,800			11,620	7,190	(23.0)
-4.5m -14.8ft	kg			*11,530	*11,530	*8,130	6,270					*6,030	4,560	5.66
	lb			*25,420	*25,420	*17,920	13,820					*13,290	10,050	(18.6)

5.68 m (18' 8") boom, 2.92 m (9' 7") arm equipped with 600 mm (24") triple grouser shoe, and 4,200 kg counterweight.

Load Point Height m (ft)	Lift-Point Radius										At Max. Reach			
	1.5m (4.9ft)		3.0m (9.8ft)		4.5m (14.8ft)		6.0m (19.7ft)		7.5m (24.6ft)		Capacity		Reach	
													m (ft)	
7.5m 24.6ft	kg							*4,440	*4,440			*3,360	*3,360	6.26
	lb							*9,790	*9,790			*7,410	*7,410	(20.5)
6.0m 19.7ft	kg							*4,410	*4,410			*3,090	*3,090	7.38
	lb							*9,720	*9,720			*6,810	*6,810	(24.2)
4.5m 14.8ft	kg							*4,920	*4,920	*4,660	3,550	*3,010	*3,010	8.07
	lb							*10,850	*10,850	*10,270	7,830	*6,640	*6,640	(26.5)
3.0m 9.8ft	kg				*7,340	*7,340		*5,740	4,830	*5,020	3,430	*3,060	2,830	8.43
	lb				*16,180	*16,180		*12,650	10,650	*11,070	7,560	*6,750	6,240	(27.7)
1.5m 4.9ft	kg				*9,060	6,880		*6,610	4,570	5,190	3,310	*3,240	2,730	8.51
	lb				*19,970	15,170		*14,570	10,080	11,440	7,300	*7,140	6,020	(27.9)
0.0m 0.0ft	kg		*5,910	*5,910	*10,050	6,580		7,080	4,390	5,080	3,210	*3,580	2,770	8.32
	lb		*13,030	*13,030	*22,160	14,510		15,610	9,680	11,200	7,080	*7,890	6,110	(27.3)
-1.5m -4.9ft	kg	*6,490	*6,490	*10,380	*10,380	*10,260	6,490	69,90	4,310	5,050	3,180	*4,190	3,000	7.84
	lb	*14,310	*14,310	*22,880	*22,880	*22,620	14,310	15,410	9,500	11,130	7,010	*9,240	6,610	(25.7)
-3.0m -9.8ft	kg	*11,110	*11,110	*14,070	12,840	*9,740	6,560	7,030	4,340			*5,400	3,550	7.00
	lb	*24,490	*24,490	*31,020	28,310	*21,470	14,460	15,500	9,570			*11,900	7,830	(23.0)
-4.5m -14.8ft	kg			*11,530	*11,530	*8,130	6,780					*6,030	4,930	5.66
	lb			*25,420	*25,420	*17,920	14,950					*13,290	10,870	(18.6)

- Lifting capacity are based on ISO 10567.
- Lifting capacity of the ROBEX series does not exceed 75% of tipping load with the machine on firm, level ground or 87% of full hydraulic capacity.
- The Lift-point is bucket pivot mounting pin on the arm (without bucket mass).
- (\*) indicates load limited by hydraulic capacity.

